

Epwin Group Ltd

Window Systems Division
Stafford Park 6
Telford
Shropshire TF3 3AT
Tel: 01952 290910 Fax: 01952 290460
e-mail: info@profile22.co.uk
website: www.epwin.co.uk



Agrément Certificate
14/5090
Product Sheet 2

EPWIN CAVITY CLOSER SYSTEMS

WINFIT CAVITY CLOSER, FORMER AND FRAME FIXING SYSTEM

This Agrément Certificate Product Sheet⁽¹⁾ relates to the Winfit Cavity Closer, Former and Frame Fixing System for use as a cavity closer and to form an opening in masonry cavity walls.

(1) Hereinafter referred to as 'Certificate'.

CERTIFICATION INCLUDES:

- factors relating to compliance with Building Regulations where applicable
- factors relating to additional non-regulatory information where applicable
- independently verified technical specification
- assessment criteria and technical investigations
- design considerations
- installation guidance
- regular surveillance of production
- formal three-yearly review.

KEY FACTORS ASSESSED

Hygrothermal behaviour — the cavity closers meet and exceed the minimum thermal-resistance path of $0.45 \text{ m}^2 \cdot \text{K} \cdot \text{W}^{-1}$ as required by the Accredited Construction Details (version 1.0). Default ψ -values (psi) in BRE Information Paper IP 1/06, therefore, may be used for jamb and sill junctions in SAP or SBEM calculations (see section 6).

Water resistance — the system is effective as a damp-proof barrier and, when used in a suitable wall construction, will resist the passage of water into the interior of the building in flush and check reveal installations (see section 7).

Structural stability — in terms of wind loading resistance, the system can be used in all areas of the UK. The system must not be used to support loads from masonry (see section 8).

Properties in relation to fire — the installed system will not contribute significantly to the growth of a fire. The system does not constitute a cavity barrier (see section 9).

Durability — the system, protected within the cavity, will continue to function for the normal expected life of a building (see section 12).



The BBA has awarded this Certificate to the company named above for the system described herein. This system has been assessed by the BBA as being fit for its intended use provided it is installed, used and maintained as set out in this Certificate.

On behalf of the British Board of Agrément

A handwritten signature in black ink, appearing to read 'John Albon'.

Date of First issue: 9 May 2014

John Albon — Head of Approvals
Energy and Ventilation

A handwritten signature in black ink, appearing to read 'Claire Curtis-Thomas'.

Claire Curtis-Thomas
Chief Executive

The BBA is a UKAS accredited certification body — Number 113. The schedule of the current scope of accreditation for product certification is available in pdf format via the UKAS link on the BBA website at www.bbacerts.co.uk

Readers are advised to check the validity and latest issue number of this Agrément Certificate by either referring to the BBA website or contacting the BBA direct.

British Board of Agrément
Bucknalls Lane
Watford
Herts WD25 9BA

©2013

tel: 01923 665300
fax: 01923 665301
e-mail: mail@bba.star.co.uk
website: www.bbacerts.co.uk

Regulations

In the opinion of the BBA, the Winfit Cavity Closer, Former and Frame Fixing System, if installed, used and maintained in accordance with this Certificate, will satisfy or contribute to satisfying the relevant requirements of the following Building Regulations (the presence of a UK map indicates that the subject is related to the Building Regulations in the region or regions of the UK depicted):



The Building Regulations 2010 (England and Wales) (as amended)

Requirement: C2(b)	Resistance to moisture
Comment:	The system has adequate resistance to the ingress of rain and wind-driven spray and so can contribute towards the wall satisfying this Requirement. See section 7 of this Certificate.
Requirement: C2(c)	Resistance to moisture
Comment:	The system will not constitute a significant condensation risk and so can contribute towards the wall satisfying this Requirement. See sections 6.2 and 6.3 of this Certificate.
Requirement: L1(a)(i)	Conservation of fuel and power
Comment:	The system can contribute to minimising heat loss at jambs and sills. See sections 6.1 and 6.2 of this Certificate.
Regulation: 7	Materials and workmanship
Comment:	The system is acceptable. See section 12 and the <i>Installation</i> part of this Certificate.
Regulation: 26	CO₂ emission rates for new buildings
Regulation: 26A	Fabric energy efficiency rates for new dwellings (applicable to England only)
Comment:	The system can contribute to minimising heat loss at jambs and sills. See sections 6.1 and 6.2 of this Certificate.



The Building (Scotland) Regulations 2004 (as amended)

Regulation: 8(1)	Durability, workmanship and fitness of materials
Comment:	The system can contribute to a construction satisfying this Regulation. See section 12 and the <i>Installation</i> part of this Certificate.
Regulation: 9	Building standards applicable to construction
Standard: 3.10	Precipitation
Comment:	The system has adequate resistance to the ingress of rain and wind-driven spray and so can contribute towards the wall satisfying this Standard, with reference to clauses 3.10.1 ⁽¹⁾⁽²⁾ and 3.10.3 ⁽¹⁾⁽²⁾ . See section 7 of this Certificate.
Standard: 3.15	Condensation
Comment:	The system will not constitute a significant condensation risk and so can contribute towards the wall satisfying this Standard, with reference to clauses 3.15.1 ⁽¹⁾ , 3.15.4 ⁽¹⁾⁽²⁾ and 3.15.5 ⁽¹⁾⁽²⁾ . See sections 6.2 and 6.3 of this Certificate.
Standard: 6.1(b)	Carbon dioxide emissions
Standard: 6.2	Building insulation envelope
Comment:	The system can contribute to minimising heat loss at jambs and sills, with reference to clauses 6.2.3 ⁽¹⁾ , 6.2.4 ⁽¹⁾⁽²⁾ and 6.2.5 ⁽²⁾ . See section 6.1 of this Certificate.
Standard: 7.1(a)(b)	Statement of sustainability
Comment:	The system can contribute to satisfying the relevant requirements of Regulation 9, Standards 1 to 6, and therefore will contribute to a construction meeting a bronze level of sustainability as defined in this Standard. In addition the system can contribute to a construction meeting a higher level of sustainability as defined in this Standard, with reference to clauses 7.1.4 ⁽¹⁾⁽²⁾ [Aspects 1 ⁽¹⁾⁽²⁾ and 2 ⁽¹⁾], 7.1.6 ⁽¹⁾⁽²⁾ [Aspects 1 ⁽¹⁾⁽²⁾ and 2 ⁽¹⁾] and 7.1.7 ⁽¹⁾⁽²⁾ [Aspect 1 ⁽¹⁾⁽²⁾]. See section 6.1 of this Certificate.
Regulation: 12	Building standards applicable to conversions
Comment:	All comments given for this system under Regulation 9, Standards 1 to 6, also apply to this Regulation, with reference to clause 0.12.1 ⁽¹⁾⁽²⁾ and Schedule 6 ⁽¹⁾⁽²⁾ . (1) Technical Handbook (Domestic). (2) Technical Handbook (Non-Domestic).



The Building Regulations (Northern Ireland) 2012

Regulation: 23	Fitness of materials and workmanship
Comment:	The system is acceptable. See section 12 and the <i>Installation</i> part of this Certificate.
Regulation: 28	Resistance to moisture and weather
Comment:	The system has adequate resistance to the ingress of rain and wind-driven spray and so can contribute towards the wall satisfying this Regulation. See section 7 of this Certificate.
Regulation: 29	Condensation
Comment:	The system will not constitute a significant condensation risk and so can contribute towards the wall satisfying this Regulation. See section 6.3 of this Certificate.
Regulation: 39(a)(i)	Conservation measures
Regulation: 40(2)	Target carbon dioxide emission rate
Comment:	The system can contribute to minimising heat loss at jambs and sills. See sections 6.1 and 6.3 of this Certificate.

Additional Information

NHBC Standards 2014

NHBC accepts the use of the Winfit Cavity Closer, Former and Frame Fixing System, provided it is installed, used and maintained in accordance with this Certificate in relation to *NHBC Standards*, Chapter 6.1 *External masonry walls*, subject to the requirements of these Standards.

Technical Specification

1 Description

1.1 The Winfit Cavity Closer, Former and Frame Fixing System is an insulated, unplasticised polyvinyl chloride (PVC-U) cavity closer and window or door sub-frame, used to form an opening in masonry cavity walls during construction. It is made from extruded profiles formed into a U-shape template, with mechanically joined (using corner cleats) corners at the sill or threshold and a temporary fixing batten (50 mm by 25 mm thick) fixed at the head (10 mm from the top) using stainless steel pan or countersunk head screws (No 8 by 16 mm). The cavity closer profiles are fitted with insulation (EPS, declared thermal conductivity λ_D 0.038 W·m⁻¹·K⁻¹). For checked reveal installations, a PVC-U bracing bar is fixed at the head using bracing shoes. The head batten or bracing bar must be removed prior to the installation of the window/door frames. For closer sub-frames over 1200 mm, an additional timber batten/bracing bar is fixed at half-height to prevent distortion. For check reveal installations, locators are screwed onto the sub-frame sill section, or sill cleats are clipped onto the window sill section 150 mm to 200 mm from corners and at 600 mm centres. A minimum of two sill locators/sill cleats per sill are required.

1.2 The cavity frame components and accessories are listed in Table 1 and shown in Figure 1.

1.3 The jamb and sill profiles are cut to size. The corner cleats are fitted first to the sill section and then the jamb sections are fitted (see Figure 2).

1.4 The main PVC-U profile incorporates a box section to fit into the recess of the wall cavity.

1.5 The cavity closer profiles are produced from reground PVC-U material.

1.6 Nylon 6 ties, manufactured by standard injection moulding techniques, are used to build the cavity closer frame into the surrounding mortar joints (see Figure 1).

Table 1 Winfit — list of components

Manufacturer's designation	Components	Application
WF37536	cavity closer/sub-frame	jamb 75 mm cavity profile
WF37526	cavity closer/sub-frame	sill/threshold 75 mm cavity profile
WF37546	cavity closer/sub-frame	jamb 75 mm cavity check reveal profile
WF38036	cavity closer/sub-frame	jamb 80 mm cavity profile
WF38026	cavity closer/sub-frame	sill/threshold 80 mm cavity profile
WF38046	cavity closer/sub-frame	jamb 80 mm cavity check reveal profile
WF39036	cavity closer/sub-frame	jamb 90 mm cavity profile
WF39026	cavity closer/sub-frame	sill/threshold 90 mm cavity profile
WF39046	cavity closer/sub-frame	jamb 90 mm cavity check reveal profile
WF31036	cavity closer/sub-frame	jamb 100 mm cavity profile
WF31026	cavity closer/sub-frame	sill/threshold 100 mm cavity profile
WF31046	cavity closer/sub-frame	jamb 100 mm cavity check reveal profile
WF312536	cavity closer/sub-frame	jamb 125 mm cavity profile
WF312526	cavity closer/sub-frame	sill/threshold 125 mm cavity profile
WF312546	cavity closer/sub-frame	sill/threshold 125 mm cavity check reveal profile
WF315036	cavity closer/sub-frame	jamb 150 mm cavity profile
WF315026	cavity closer/sub-frame	sill/threshold 150 mm cavity profile
WF315046	cavity closer/sub-frame	jamb 150 mm cavity check reveal profile
WF2506	tie/lug	cavity closer tie
WF2470	fixing clip	for securing window outer frame jambs to cavity closer sub-frame
WF1865	sill cleat	for securing window outer frame to sill of cavity closer sub-frame
WF2510	sill locator	for securing window outer frame to sill of cavity closer sub-frame
WF3560	corner cleat	for mechanically joining cavity closer sub-frame
—	softwood batten	head batten (typical 50 mm x 25 mm)
WF2502	PVC-U brace	bracing bar
WF2516	PVC-U shoe	for fixing bracing bar
WF3724	EPS block	insulation for cavity closer profiles
WF3728	EPS block	insulation for cavity closer profiles
WF3729	EPS block	insulation for cavity closer profiles
—	stainless steel screws (No 8 x 16 mm)	timber head batten fixing screws
—	stainless steel screws (4.3 diameter 16 mm)	bracing shoes fixing screws
—	stainless steel screws (4.3 mm diameter 16 mm countersunk head)	fixing clip fixing screws

Figure 1 Winfit components

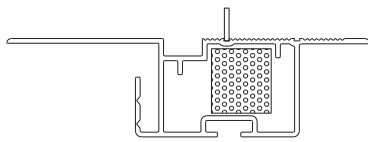

WF37536
75 mm cavity — jamb

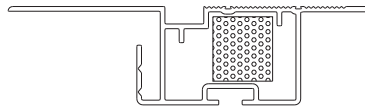

WF37526
75 mm cavity — sill

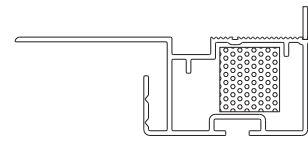

WF37546
75 mm cavity — jamb in-check

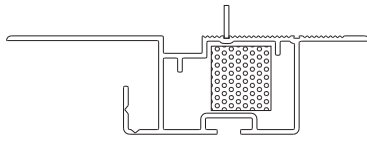

WF38036
80 mm cavity — jamb

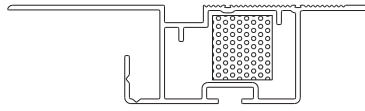

WF38026
80 mm cavity — sill

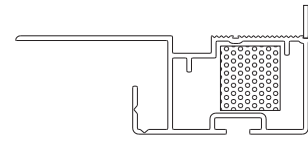

WF38046
80 mm cavity — jamb in-check

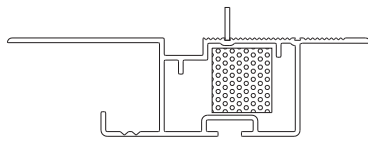

WF39036
90 mm cavity — jamb

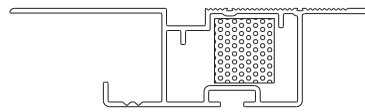

WF39026
90 mm cavity — sill

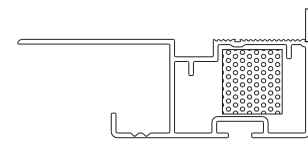

WF39046
90 mm cavity — jamb in-check

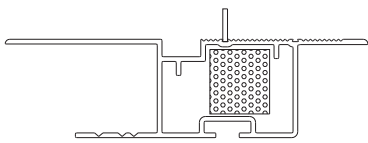

WF31036
100 mm cavity — jamb

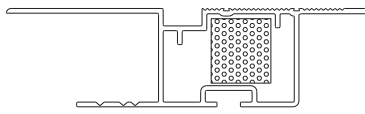

WF31026
100 mm cavity — sill

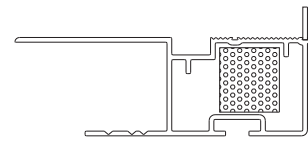

WF31046
100 mm cavity — jamb in-check

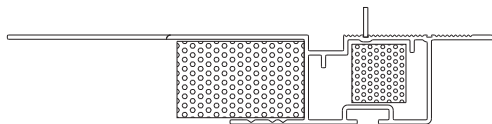

WF312536
125 mm cavity — jamb

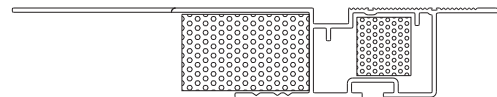

WF312526
125 mm cavity — sill

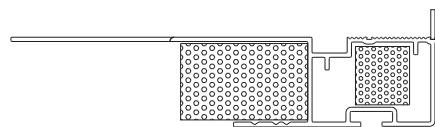

WF312546
125 mm cavity — sill in-check

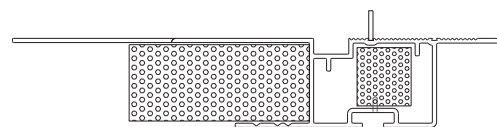

WF315036
150 mm cavity — jamb

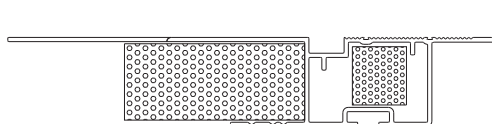

WF315026
150 mm cavity — sill

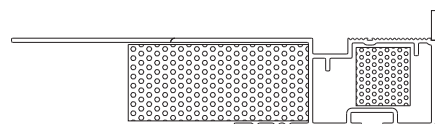

WF315046
150 mm cavity — sill in-check

Figure 1 Winfit components (continued)

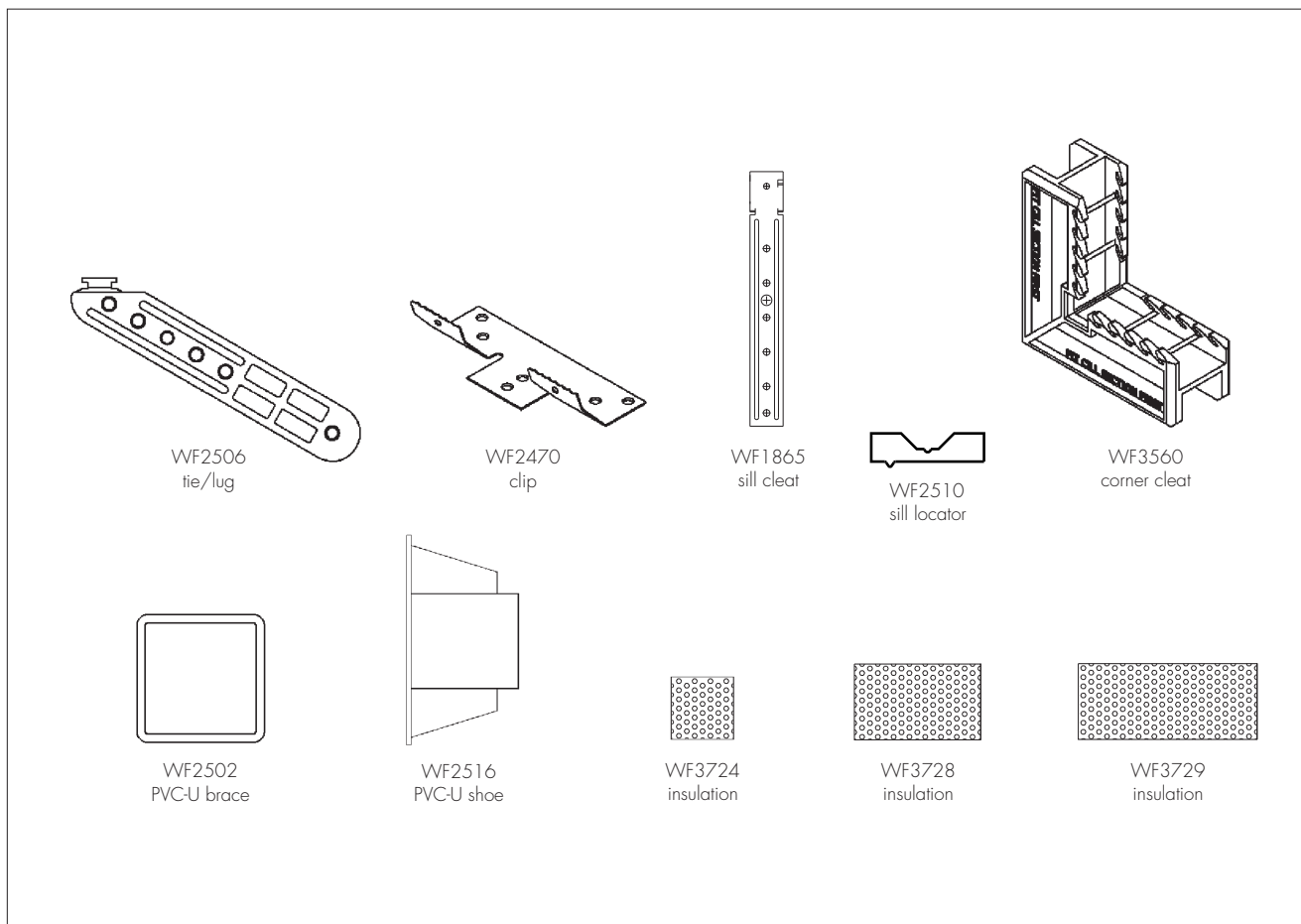

2 Manufacture

2.1 The cavity closer unplasticised polyvinyl chloride (PVC-U) profiles are produced by conventional extrusion techniques. The insulation is fitted in the factory.

2.2 As part of the assessment and ongoing surveillance of product quality, the BBA has:

- agreed with the manufacturer the quality control procedures and product testing to be undertaken
- assessed and agreed the quality control operated over batches of incoming materials
- monitored the production process and verified that it is in accordance with the documented process
- evaluated the process for management of nonconformities
- checked that equipment has been properly tested and calibrated
- undertaken to carry out the above measures on a regular basis through a surveillance process, to verify that the specifications and quality control operated by the manufacturer are being maintained.

2.3 The management system of the manufacturer has been assessed and registered as meeting the requirements of BS EN ISO 9001 : 2008 by BSI (Certificate FM 01034).

Figure 2 Winfit sub-frame fabrication

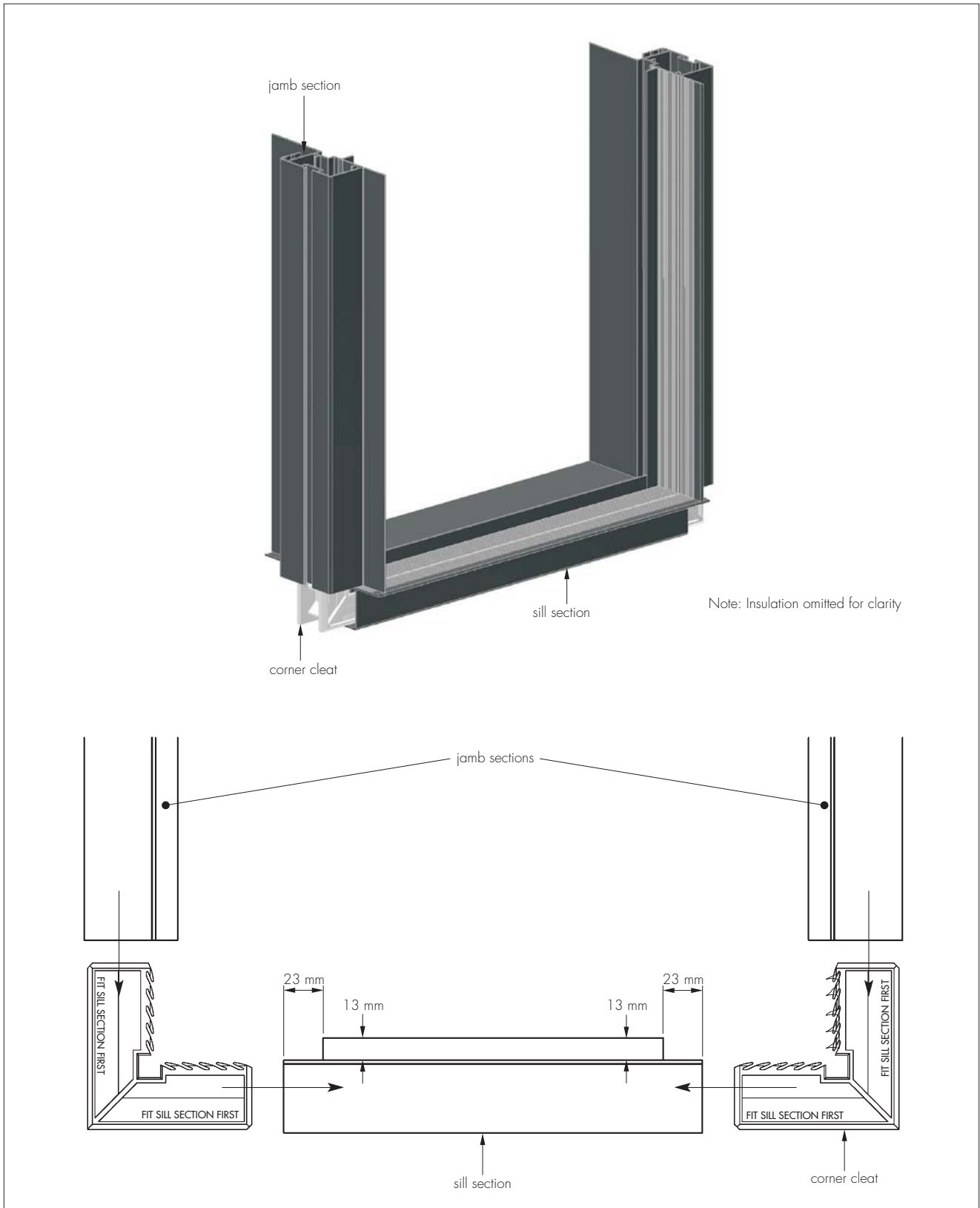

Figure 3 Typical head with window detail

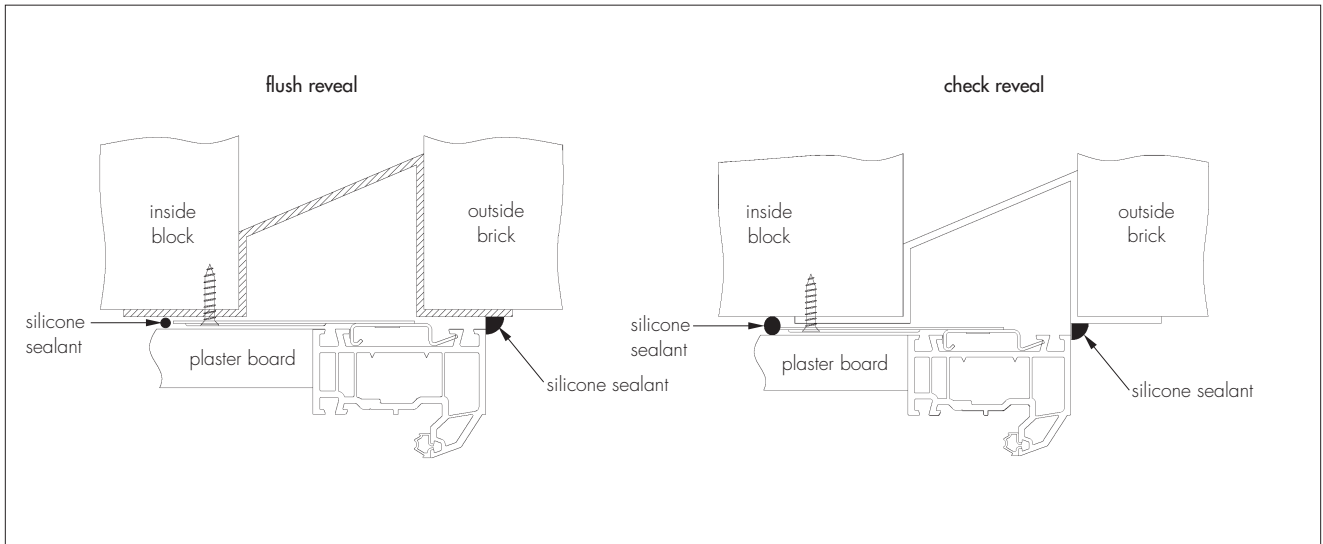
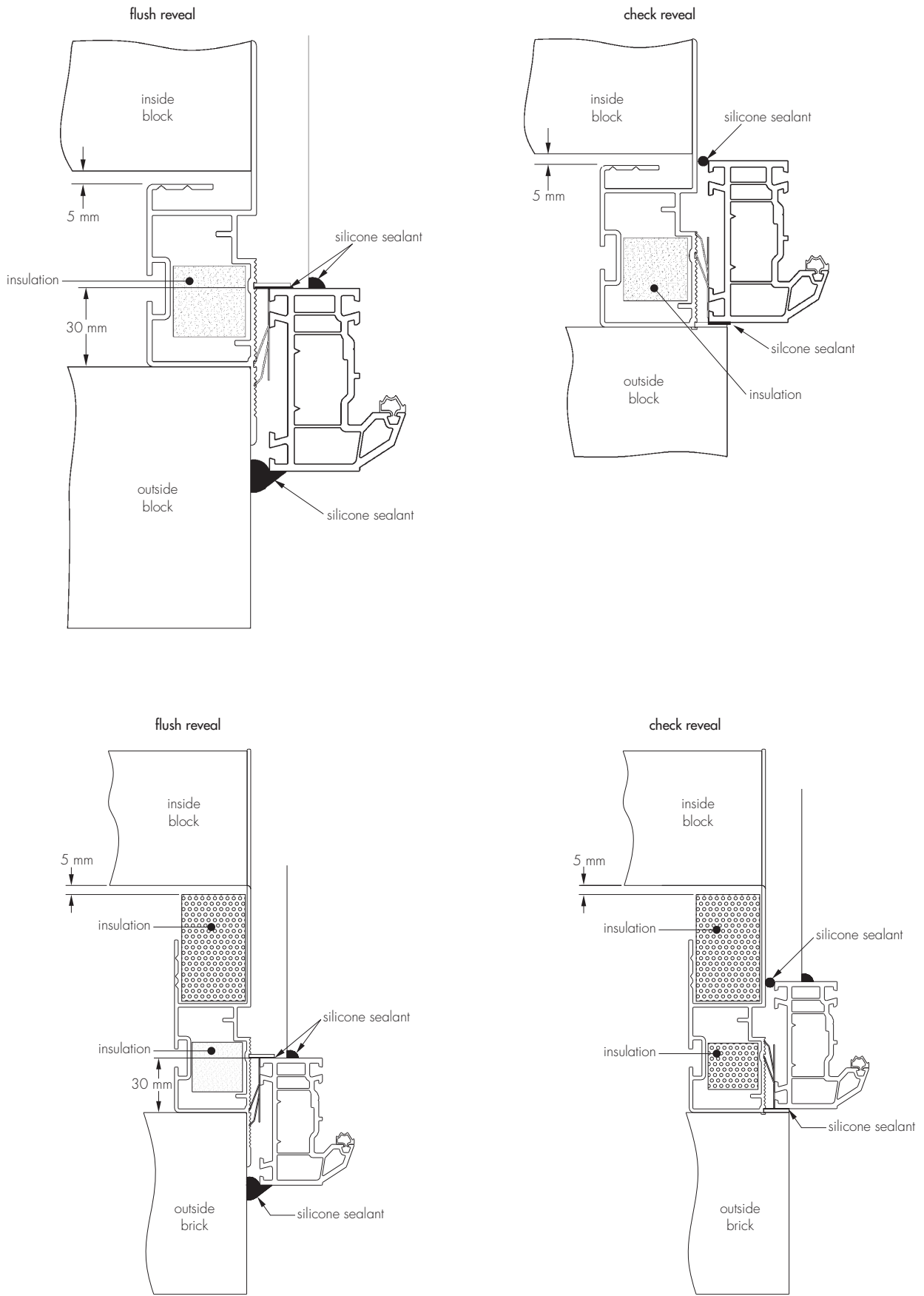

Figure 4 Typical jamb with window detail



Note: An additional cavity barrier is required in Scotland and Northern Ireland.

3 Delivery and site handling

3.1 Assembled sub-frames are labelled with system identification. They are dispatched along with the requisite number of ties, any additional ancillary items and installation instructions.

3.2 Alternatively, the cavity closer profiles are delivered to site in polythene sleeves, each bearing a product identification label. They are dispatched with the corner cleats for mechanically joining the profiles on site, the requisite number of ties, any additional ancillary items and installation instructions.

3.3 Assembled sub-frames are stacked vertically and delivered as individual items, taking care to avoid distortion in transit. The sub-frames or profiles should be stored under cover in a clean area, on edge in the case of sub-frames, and suitably supported to avoid distortion or damage. The sub-frames and profiles should be protected from vehicular and pedestrian traffic.

Assessment and Technical Investigations

The following is a summary of the assessment and technical investigations carried out on the Winfit Cavity Closer, Former and Frame Fixing System.

Design Considerations

4 Use

4.1 The Winfit Cavity Closer, Former and Frame Fixing System is suitable for use in masonry walls with nominal cavity widths in the range of 75 mm to 150 mm and with window and door frames made from PVC-U, timber, aluminium or steel. Windows must have an outer frame design suitable for correct fitting of the fixing clips or, alternatively, through-fixing can be used. The Certificate holder can advise on the suitability of outer frame profiles.

4.2 The system can be used as a template, to form an opening around which a wall can be constructed and to establish the cavity width during construction.

4.3 The system provides a damp-proof barrier, acts as a cavity closer without forming a thermal bridge, and avoids the need for cutting bricks and blocks. The window/door is fitted after completion of the masonry. It can also be used to form a checked reveal where required and to fit the window after completion of the masonry, as is conventional practice in Scotland and Northern Ireland.

4.4 Masonry walls into which cavity closers are incorporated must be constructed in accordance with one or more of the following technical specifications:

- BS EN 1996-1-1 : 2005, BS EN 1996-1-2 : 2005, BS EN 1996-2 : 2006 and BS EN 1996-3 : 2006 and their respective National Annexes
- the National Building Regulations:

England and Wales — Approved Document A1/2, section 1C

Scotland — Mandatory Standard 1.1⁽¹⁾⁽²⁾, *Small Buildings Guide*

(1) Technical Handbook (Domestic).

(2) Technical Handbook (Non-Domestic).

Northern Ireland — Technical Booklet D.

4.5 Windows and doors are fitted into the sub-frame from the outside or inside of the building.

4.6 Sub-frames are manufactured to suit the exact window/door size. A 5 mm ± 2 mm clearance per side is allowed between the sub-frame and window or door, in accordance with the *Winfast/Winfit Window Former & Cavity Closer Technical Manual*.

4.7 The maximum sub-frame cavity closer size is 2400 mm wide by 2400 mm high, maximum perimeter 7900 mm for windows and for doors. Doors require additional proprietary fixings (outside the scope of this Certificate).

5 Practicability of installation

The system is designed to be installed by a competent general builder, or a contractor, experienced with this type of system.

6 Hygrothermal behaviour

 6.1 The cavity closer can contribute to maintaining continuity of thermal insulation at jambs and sills in wall openings. The path of minimum thermal resistance through the product calculated at BRE Information Paper IP 8/08 is at least 0.45 m²·K·W⁻¹ when used in jambs and sills with the window/door frame set-back 30 mm. Example junction details shown in Figures 4 and 5 are acceptable and the corresponding heat loss rates ψ-values (psi) in BRE Information Paper IP 1/06, Table 3, may be used in carbon emission calculations in Scotland and Northern Ireland. Attention must be given to the correct setback to ensure compliance with these requirements. Detailed guidance on limiting heat loss and air infiltration can be found in:

England and Wales — Approved Documents to Part L and, for new thermal elements to existing buildings, Accredited Construction Details (version 1.0). For new-build, see also SAP 2009 Appendix K and the *iSBEM User Manual*

Scotland — Accredited Construction Details (Scotland)

Northern Ireland — Accredited Construction Details (version 1.0).



6.2 Jamb and sills incorporating the system, in accordance with section 6.1, will adequately limit the risk of local surface condensation.



6.3 Under normal domestic conditions, the level of interstitial condensation associated with the system will be low and the risk of any resultant damage minimal.

6.4 Door frames installed with proprietary fixings which cannot be set back into the wall cavity by 30 mm (see section 6.1) may require additional thermal insulation, for example dry lining, to minimise excessive heat loss and the risk of excessive surface condensation.

6.5 The junctions between the wall and the front and back of the window/door frame must be sealed effectively.

7 Water resistance



7.1 The system is effective as a vertical damp-proof barrier at jambs of window and door openings in masonry constructions where a brick/block closer and damp-proof course (dpc) detail would normally be used. The system is also effective as a horizontal damp-proof barrier at the sill or threshold.

7.2 Installations with a flush (in-line) wall opening and a minimum setback of 30 mm (see Figures 3, 4 and 5 and section 6.1) are suitable for use in exposure zones 1 (sheltered) and 2 (moderate) as depicted in the map contained in section 3.1 of BRE Report BR 262 : 2002. The sub-frame may also be considered for use in other areas where a conventional return brick/block closer detail with dpc has been found to provide adequate resistance to the penetration of wind-driven rain.

7.3 The system may also be used to construct a check reveal (see Figures 3, 4 and 5). In this construction, in which the frame is positioned in a rebate behind the outer leaf of the jamb, the system is suitable for use in exposure zones up to and including zone 4 (very severe) as is depicted in the map contained in section 3.1 of BRE Report BR 262 : 2002 which covers all exposure zones in the United Kingdom.

8 Structural stability

8.1 The system is non-loadbearing and must not be used to support loads from the masonry. Lintels are required above window or door openings.

8.2 The system will not have an adverse effect on the structural stability of brickwork or blockwork walls constructed in the conventional manner in accordance with normal good practice as defined in the Standards listed in section 4.4 of this Certificate. Use of the system does not obviate the need for conventional wall ties around the openings.

8.3 A window fitted correctly into a cavity frame, using fixing clips at the jambs, sill cleats at the sill and conventional fixing lugs at the head, will satisfactorily transfer to the structure wind loads likely to be encountered in the UK. In terms of wind loading resistance, the cavity frame can be used in all areas of the UK.

8.4 The alternative method of window frame fixing using lugs, or through fixing into the masonry, provides similar resistance to wind loading to that described in section 8.3.

8.5 Door frames for use with the cavity frame require additional proprietary fixings at the jambs and sill/threshold to ensure that the frame remains firmly fixed when the door is slammed. Head fixings may be required for larger doorsets. Reference should be made to the relevant installation procedures described in the *Winfast/Winfit Window Former & Cavity Closer Technical Manual*.

9 Properties in relation to fire

9.1 The installed system will not contribute significantly to the growth of a fire.

9.2 The system does not constitute a cavity barrier against the penetration of smoke and flame in the context of the Building Regulations.

9.3 The use of the system is not prevented in England and Wales where, generally, cavity barriers are not required around openings in masonry wall construction.

9.4 In Scotland and Northern Ireland the system is only suitable for use in conjunction with a cavity barrier meeting the performance requirements defined in:

Scotland — Mandatory Standard 2.4, clause 2.4.1⁽¹⁾⁽²⁾ and Annex 2.B⁽¹⁾ or 2.D⁽²⁾

(1) Technical Handbook (Domestic).

(2) Technical Handbook (Non-Domestic).

Northern Ireland — Technical Booklet E, Paragraph 4.38.

9.5 The use of the system does not preclude the need to provide suitable fire protection to steel lintels where this is necessary to satisfy the Building Regulations.

Figure 5 Typical sill with window detail

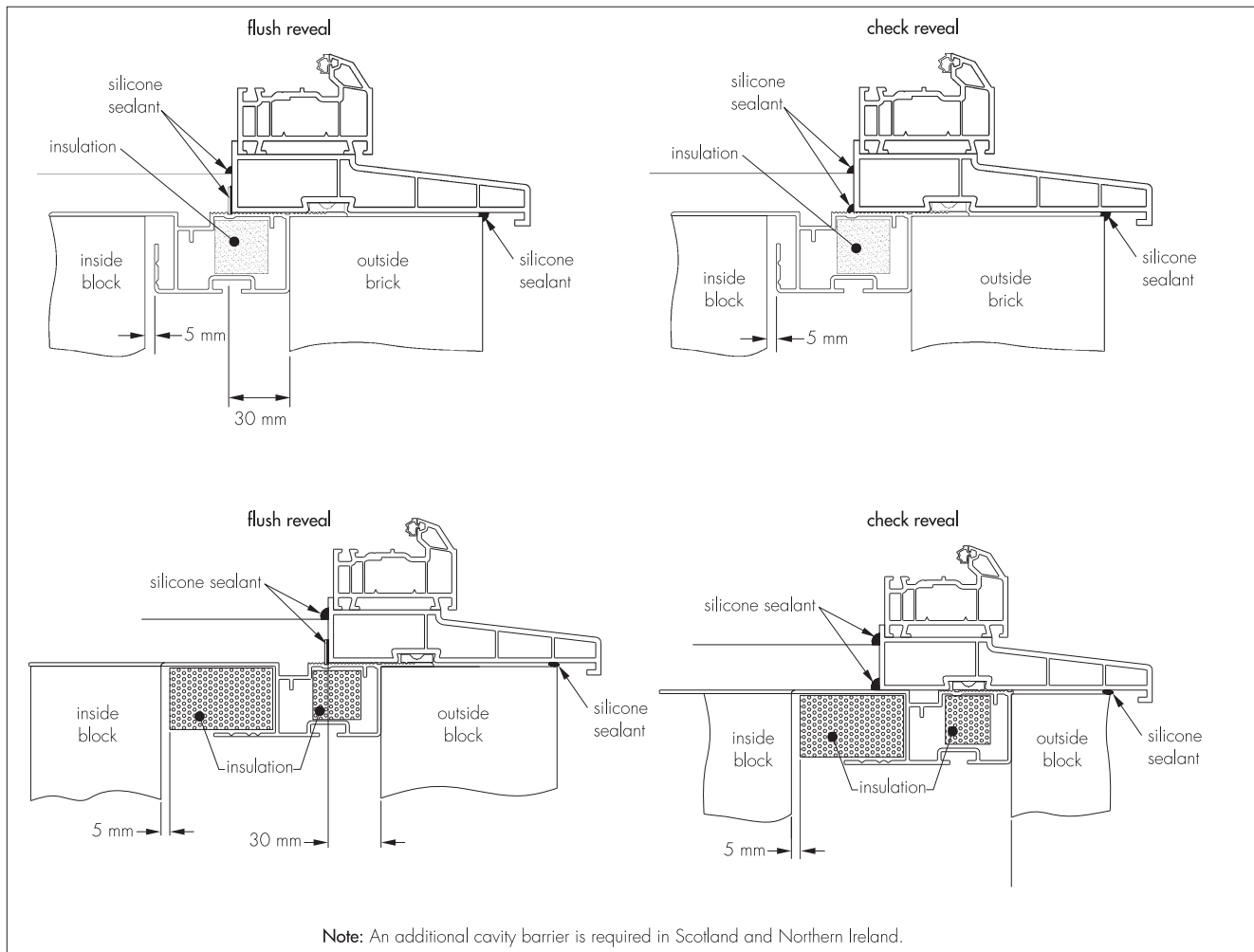

10 Security against intrusion

Removal of a window from the cavity frame from outside is extremely difficult as the shape of the outer frame prevents access to the locating clips. If required, supplementary through fixing of the window frame is possible. The fixing of door frames are secured by lugs or through fixings around the perimeter is outside the scope of this Certificate.

11 Maintenance

To ensure maximum weathertightness, the silicone seal between window or door frames and masonry must be checked regularly and repairs or renewal carried out promptly.

12 Durability



The system is durable when installed in accordance with this Certificate and will not suffer significant degradation when protected within the cavity. The system will continue to function for the normal expected life of a building.

Installation

13 General

13.1 Installation of the Winfit Cavity Closer, Former and Frame Fixing System must be carried out in accordance with the *Winfast/Winfit Window Former & Cavity Closer Technical Manual*.

13.2 A cavity barrier may be required (see section 9.2 of this Certificate).

13.3 Reference should be made to the typical installation details shown in Figures 3, 4 and 5 when reading the installation details given in section 14 of this Certificate. The windows in these Figures are shown for information only and do not form part of this assessment.

13.4 At the build-in stage it must be ensured that the sub-frame remains plumb, level, square, and with parallel sides.

13.5 The junctions between the wall and the front and back of the window/door frame must be sealed effectively.

14 Procedure

14.1 The assembled sub-frame including timber head batten or PVC-U bracing bar is ready for building into the construction of cavity walls using traditional building methods.

14.2 The cavity wall is built to the sill level, ensuring that the course work is level and flat, and that all excess mortar is removed.

14.3 The sub-frame is positioned in the cavity with the plaster stop in the correct position relative to the cavity, so that the inner surface of the window frame is set in 30 mm from the inner surface of the outer leaf, and temporary timber supports are attached to the closer, if required. The closer frame is aligned with a spirit level and the timber supports are secured so that they are rigid and they will keep the frame square and plumb. The course work is built up by one course and butted to one side of the sub-frame.

14.4 The position of the sub-frame is checked and the course work on the opposite side of the sub-frame is built up by one level.

14.5 Ties are inserted into the channel of the sub-frame jambs, rotated through 90° and built into the mortar bed joints. These ties should be fitted after the first brick course and then at 300 mm centres. The ties should be inserted alternately, tying the sub-frame into both inner and outer courses ensuring that the sub-frame is tight against the outer brick leaving a 5 mm clearance on the inside between the internal blockwork and the cavity closer (see Figure 4). A minimum of three ties per vertical member is required.

14.6 When the masonry reaches head level, the head batten/bracing bar and any bracing support, if used, are removed (except in check reveal installations where the bracing bar is removed before the final brick course is added) and a lintel, with associated dpc, is fitted across the masonry just clear of the top of the sub-frame. The wall construction is continued to complete the aperture.

14.7 In check reveal installations, sill locators are screwed onto the sill section of the sub-frame 150 mm to 200 mm from corners and at 600 mm centres. A minimum of two sill locators per sill are required. For sub-frames exceeding 1200 mm, a 50 mm length of sill locator is screwed onto the sill section of the sub-frame. The bracing bar is removed before the final brick course is added to allow access to the PVC-U shoe fixing screws.

14.8 In all installations, the top brick course should be arranged to ensure that, when bedded in, the lintel does not exert a load on the window or door frame/sub-frame.

14.9 The sub-frame is cleaned to ensure that it is free from mortar. The brickwork must be allowed to set before attempting to fit the window/door.

14.10 The fitting of windows or doors to the sub-frame must be carried out in accordance with the *Winfast/Winfit Window Former & Cavity Closer Technical Manual*.

Window preparation and fitting

14.11 The correct window is selected to suit the sub-frame. All protective wrapping is removed.

14.12 Jamb clips are screw-fixed to the outer frame jambs (see Figure 4) 150 mm to 250 mm from each corner and at centres not exceeding 600 mm. A minimum of two clips per vertical member is required.

14.13 Where applicable, sill cleats are clipped to the outer frame sill section 150 mm to 250 mm from each corner and at centres not exceeding 600 mm. A minimum of two cleats per sill section are required.

14.14 A bead of silicone sealant is applied to the upstand of the sub-frame.

14.15 For windows fitted from outside the building, the window is offered up to the sub-frame, positioning it squarely in the aperture and clipped into place by applying even pressure to position the window back against the sub-frame flange. The head member of the window is secured using lugs or screw fixings positioned not less than 150 mm from the corners and at centres not exceeding 600 mm.

14.16 For windows fitted from the inside of the building, the window is offered up to the sub-frame from the inside of the building and installed as described in section 14.15 of this Certificate. Sill cleats, where applicable, are tied back to the building.

Finishing

14.17 An effective sealant is applied around the perimeter of the window/door internally, prior to applying internal finishes.

14.18 In locations where the plaster may be subject to repeated impact (eg at door reveals from door slamming) it is recommended that wet plaster be replaced by dry lining.

14.19 Finishing trims are fitted after completion of the window installation, where required.

14.20 The window is weather-proofed externally, using a suitable low modulus silicone sealant.

15 Tests

15.1 Tests were carried out on PVC-U extrusions made from reground material, to determine:

- Vicat softening temperature
- shrinkage on heating
- changes on heating
- ash content
- induction time of dehydrochlorination.

15.2 Tests were carried out on a combined sub-frame and PVC-U window, installed in a test rig, to determine:

- air permeability
- watertightness
- effect of cyclic wind loads to ± 1250 Pa
- effect of temperature variation (-5°C to 55°C)
- safety test, wind loading using increased pressure of 3000 Pa and reduced pressure of 3000 Pa⁽¹⁾.

(1) The test was performed at reduced temperature to ensure that the contraction of the window under such conditions would not render the system unsafe.

16 Investigations

16.1 An assessment was made of:

- heat loss and condensation risk in accordance with the Accredited Construction Details (version 1.0) and the Accredited Construction Details (Scotland)
- weather resistance of the system
- the practicability of the installation
- fire resistance and structural stability of walls incorporating the frame acceptor
- durability of the components used in the construction of the system.

16.2 The manufacturing process was evaluated, including methods for quality control, and details were obtained of the quality and composition of the materials used.

Bibliography

- BS EN 1996-1-1 : 2005 *Eurocode 6 : Design of masonry structures — General rules for reinforced and unreinforced masonry structures*
- NA to BS EN 1996-1-1 : 2005 *UK National Annex to Eurocode 6 : Design of masonry structures — General rules for reinforced and unreinforced masonry structures*
- BS EN 1996-1-2 : 2005 *Eurocode 6 : Design of masonry structures — General rules — Structural fire design*
- NA to BS EN 1996-1-2 : 2005 *UK National Annex to Eurocode 6 : Design of masonry structures — General rules — Structural fire design*
- BS EN 1996-2 : 2006 *Eurocode 6 : Design of masonry structures — Design considerations, selection of materials and execution of masonry*
- NA to BS EN 1996-2 : 2006 *UK National Annex to Eurocode 6 : Design of masonry structures — Design considerations, selection of materials and execution of masonry*
- BS EN 1996-3 : 2006 *Eurocode 6 : Design of masonry structures : Simplified calculation methods for unreinforced masonry structures*
- NA to BS EN 1996-3 : 2006 *UK National Annex to Eurocode 6 : Design of masonry structures : Simplified calculation methods for unreinforced masonry structures*
- BS EN ISO 9001 : 2008 *Quality management systems — Requirements*
- BRE Information Paper IP 1/06 *Assessing the effects of thermal bridging at junctions and around opening*
- BRE Information Paper IP 8/08 *Determining the minimum thermal resistance of cavity closers*
- BRE Report BR 262 : 2002 *Thermal insulation: avoiding risks*

17 Conditions

17.1 This Certificate:

- relates only to the product/system that is named and described on the front page
- is issued only to the company, firm, organisation or person named on the front page — no other company, firm, organisation or person may hold or claim that this Certificate has been issued to them
- is valid only within the UK
- has to be read, considered and used as a whole document — it may be misleading and will be incomplete to be selective
- is copyright of the BBA
- is subject to English Law.

17.2 Publications, documents, specifications, legislation, regulations, standards and the like referenced in this Certificate are those that were current and/or deemed relevant by the BBA at the date of issue or reissue of this Certificate.

17.3 This Certificate will remain valid for an unlimited period provided that the product/system and its manufacture and/or fabrication, including all related and relevant parts and processes thereof:

- are maintained at or above the levels which have been assessed and found to be satisfactory by the BBA
- continue to be checked as and when deemed appropriate by the BBA under arrangements that it will determine
- are reviewed by the BBA as and when it considers appropriate.

17.4 The BBA has used due skill, care and diligence in preparing this Certificate, but no warranty is provided.

17.5 In issuing this Certificate, the BBA is not responsible and is excluded from any liability to any company, firm, organisation or person, for any matters arising directly or indirectly from:

- the presence or absence of any patent, intellectual property or similar rights subsisting in the product/system or any other product/system
- the right of the Certificate holder to manufacture, supply, install, maintain or market the product/system
- actual installations of the product/system, including their nature, design, methods, performance, workmanship and maintenance
- any works and constructions in which the product/system is installed, including their nature, design, methods, performance, workmanship and maintenance
- any loss or damage, including personal injury, howsoever caused by the product/system, including its manufacture, supply, installation, use, maintenance and removal
- any claims by the manufacturer relating to CE marking.

17.6 Any information relating to the manufacture, supply, installation, use, maintenance and removal of this product/system which is contained or referred to in this Certificate is the minimum required to be met when the product/system is manufactured, supplied, installed, used, maintained and removed. It does not purport in any way to restate the requirements of the Health and Safety at Work etc. Act 1974, or of any other statutory, common law or other duty which may exist at the date of issue or reissue of this Certificate; nor is conformity with such information to be taken as satisfying the requirements of the 1974 Act or of any statutory, common law or other duty of care.